



Alsey Outdoor Wood-Fired Oven

Alsey Refractories Company
1600 S. Brentwood Blvd.
St. Louis, MO 63144

314-963-7900

www.alsey.com

Alsey Outdoor Wood-Fired Oven

- Warnings
- Pre-Assembly Information
- Components Listing
- Assembly Instructions
- How To Cure Your Oven
- Getting Started

OPERATORS SHOULD BE AT LEAST 18 YEARS OF AGE.

EXTREME CAUTION should be used. Oven components are extremely hot when in use and will remain hot for hours after use.

NEVER use gasoline or other accelerants to start or maintain a fire in this oven. Items of this nature should be kept away from the oven while in use.

DO NOT use this oven to warm a room.

DO NOT throw chunks of wood into the oven.

DO NOT allow any type of liquid to touch the hearth or dome while hot. For example: when cooking burgers on a grill grate you will need to create a bed of coals underneath.

ALWAYS pre-warm cooking accessories before placing in the oven. Placing a cold accessory on a hot heart may cause the hearth to crack.

ALWAYS use dry wood. Using wood that is not dry will cause the oven to smoke considerably and may cause damage to the oven.

Alsey Outdoor Wood-Fired Oven Pre-Assembly

YOU ARE RESPONSIBLE FOR FOLLOWING ALL LOCAL BUILDING CODES.

Consult local building codes or contact local fire officials about restrictions and installation inspection requirements in your area.

To avoid any hazards during installation, you must comply to the following minimum requirements for clearance between your oven and any combustible materials.

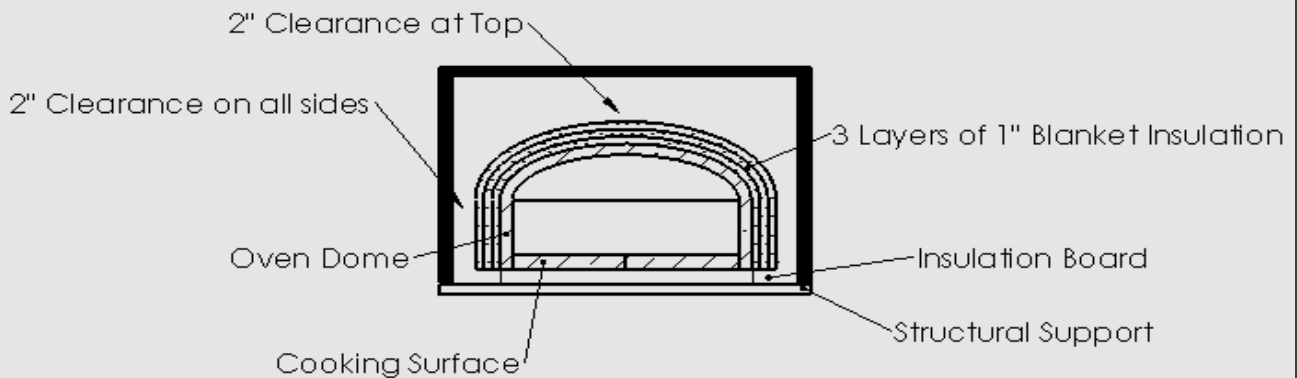

Support Base Assembly

PREPARE YOUR BASE PRIOR TO INSTALLATION

- ❖ Your support base should be large enough to support the finished dimensions of the oven and decorative surround.
- ❖ Your support base must be able to support a minimum of 750 pounds, which does not include the additional weight of your decorative surround.

Aley Outdoor Wood-Fired Oven Components Listing

Parts Included:

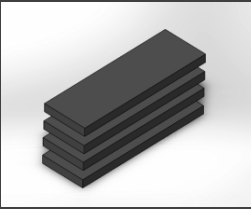

Insulating Boards

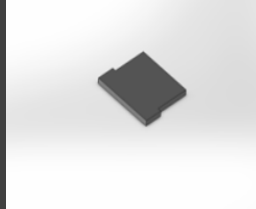

Hearth Piece A

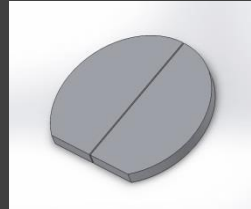

Hearth Piece B

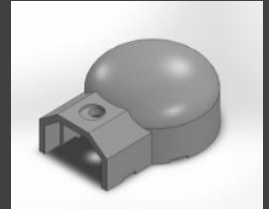

Dome



Mortar



Ceramic Blanket

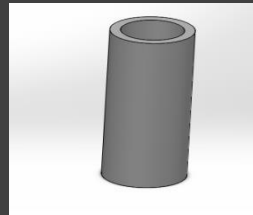

Clay Flue



Door Arch



Door

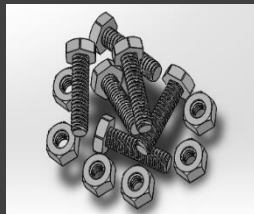

Hardware



Rain Guard

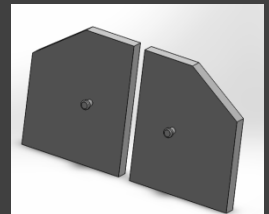

Insulating Door

Alsey Outdoor Wood-Fired Oven Assembly Instructions

ALSEY OUTDOOR WOOD-FIRED OVEN SHOULD BE INSTALLED BY A PROFESSIONAL OR SUITABLY QUALIFIED INDIVIDUAL

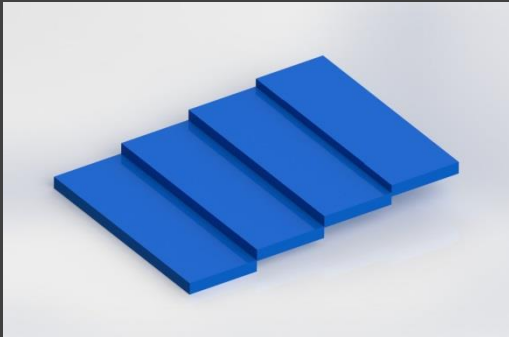

STEP 1:

Lay out insulating boards onto a flat surface.

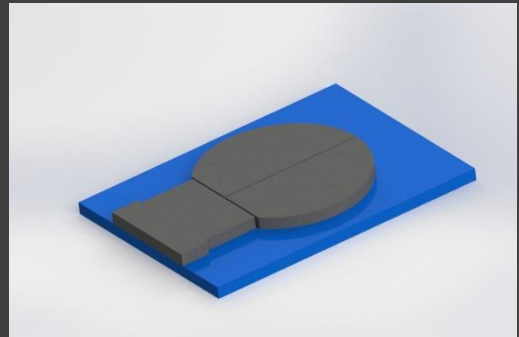

STEP 2:

Place all hearth pieces (as shown in picture) onto the boards

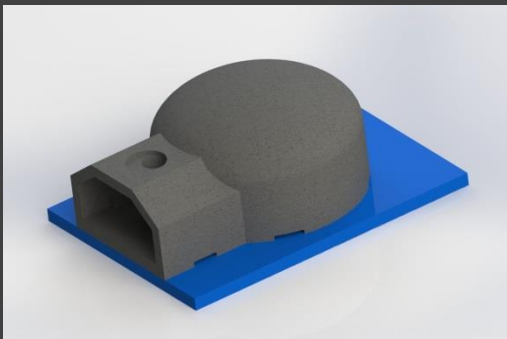

STEP 3:

Carefully place the dome over the hearth pieces.

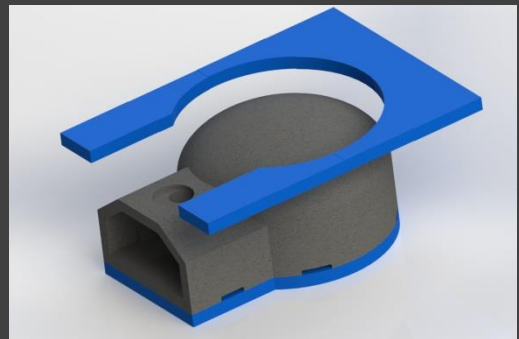

STEP 4:

- A. Trace the outline of the dome onto the base boards
- B. Disassemble the placed pieces from the base boards
- C. Cut the base boards with a jig saw around the traced line.

Alsey Outdoor Wood-Fired Oven Assembly Instructions

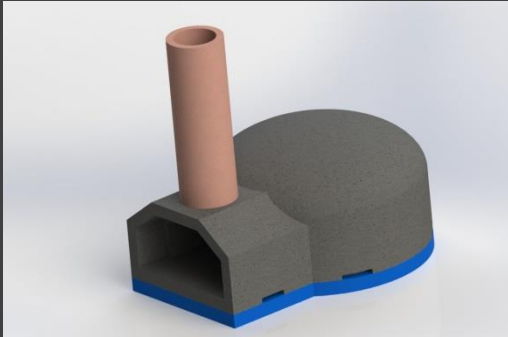

STEP 5:

- A. Place the hearth pieces onto the cut boards & mortar the pieces into place
- B. Set the dome over the hearth.
- C. Set clay flue into place & surround with ceramic fibers

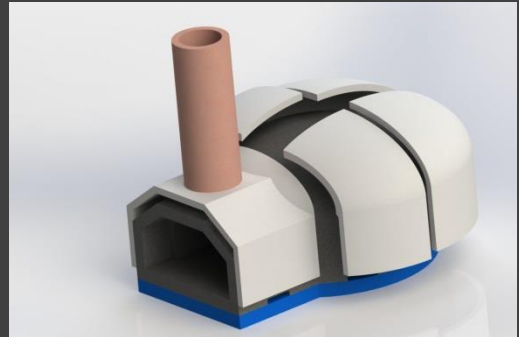

STEP 6:

- A. Cut a layer of ceramic blanket, to cover the dome and hearth pieces, as shown.
- B. Apply mortar to hold the blanket in place

Repeat twice to form two additional layers over the dome.

*Note: It is recommended to add mortar to the door frame before attaching the door in step 7.

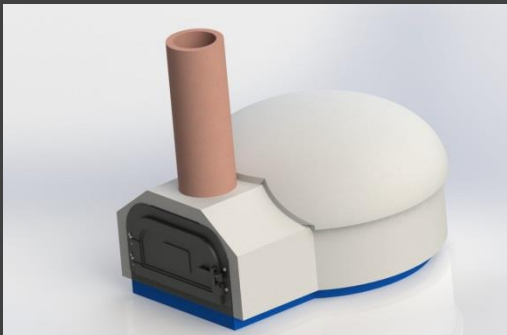

STEP 7:

With supplied bolts, attach the door to the dome.

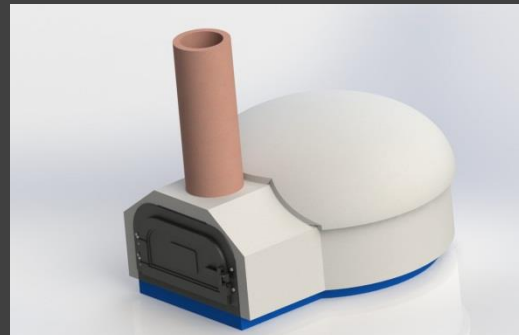

STEP 8:

Place the rain guard over the clay flue



Alsey Outdoor Wood-Fired Oven Instructions

How To Cure Your Outdoor Oven

The oven may seem dry once installation is complete; however, there are still small amounts of moisture that need to be removed. The initial fire should be kept low, allowing moisture to release slowly.

Building a large fire prior to curing may cause permanent damage to your oven.

Curing is conducted by maintaining a temperature at or below 212°F/100°C for approximately 72 hours.

To avoid heating to a temperature that exceeds this limit, it is recommended that you build a fire away from the oven and utilize the hot coals to generate heat.

Small cracks may appear in the dome or the hearth while curing. This is a normal result of thermal expansion and does not compromise the integrity of your oven.

It is recommended that you re-cure your oven anytime it sits for a long period of time or is exposed to a lot of moisture.

Cooking In Your Outdoor Oven

When firing your oven always start with dry kindling in the rear of the oven. When the dome of your oven turns whitish grey you are ready to begin cooking!

NEVER USE CHEMICALS OR STARTER FLUIDS TO START OR MAINTAIN YOUR FIRE.

There are two ways to cook in your oven: open-door and closed-door .

Open door cooking is utilized for foods that require medium to high heat. To create these temperatures keep your fire burning in the back of the oven.

Closed door cooking is great for breads, roasts , and casseroles. Build the fire to spread within the whole oven. For a minimum of an hour. Allow the fire to burn down (the longer the fire is burning the more heat you will produce). Remove all the coals and sweep the hearth when you are ready to begin cooking . Place your food into the front of the oven and seal the dome with the insulating door.

It is recommended that you fire your oven to the appropriate temperature and cook something simple that can be thrown away for the first two cycles of use.